

# 86

## EUROPROFILE CYLINDER SECURITY LOCKS

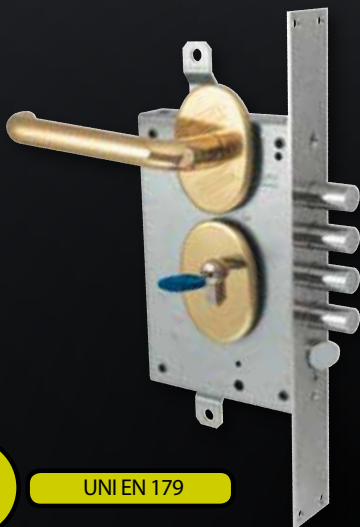

UNI EN 179



UNI EN 1125

Panic exit bar



UNI EN 1125

Emergency exit handle



UNI EN 179



**WARNING:**

Each and every part (in particular, lock, switchlock, bars) of GOOUT locks are, certified by ICIM according to reference standards.

Any modification of the product as a whole, or the installation in disregard of the instruction manual will automatically void the certification.

In this case the installer is responsible for conformity with the reference standards.

**Category of use**  
Only one category of use is identified with level 3

**Maximum life**  
Two categories are identified  
- Level 6 100,000 cycles  
- Level 7 200,000 cycles

**Door mass**  
Three categories are identified  
- level 5 up to 100 kg  
- level 6 up to 200 kg  
- level 7 over 200 kg

**Fire resistance**  
Three categories are identified  
- level 0 not appropriate for use on antismoke/fire barrier doors  
- level A appropriate for use on antismoke barrier doors  
- level B appropriate for use on antismoke/fire barrier doors

**Security for individuals**  
Only one category with level 1 is identified

**Resistance to corrosion**  
Two categories are identified  
- level 3 high resistance  
- level 4 very high resistance

**Security for property**  
Only one category with level 2 is identified for UNI EN 1125 and level from 2 to 5 for UNI EN 179

**Protrusion of bar**  
Two categories are identified  
- level 1 protrusion up to 150 mm. (normal protrusion)  
- level 2 protrusion up to 100 mm. (reduced protrusion)

**Bar activation**  
Two categories are identified  
- level A actioning by means of push bar  
- level B actioning by means of contact bar

**Door applications**  
Three categories are identified  
- level A one- or two-leaf doors: active or passive door leaf  
- level B one-leaf door  
- level C two-leaf door with one passive door leaf only

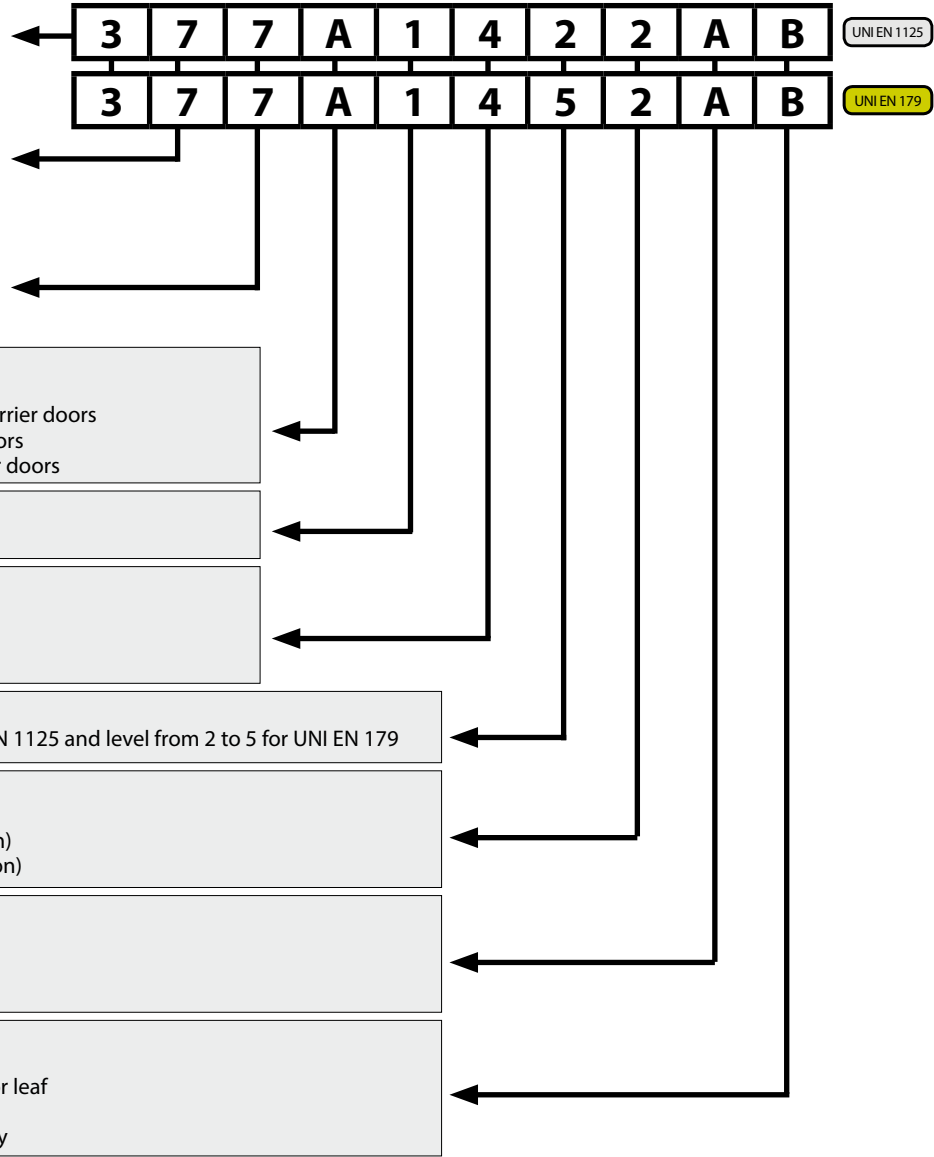



GOOUT is suitable to be applied to fire doors but **must be tested with the door**. Any substitution is possible only on fire doors that have the specific certificate showing panic GOOUT.



## 86.G870

MADE IN ITALY

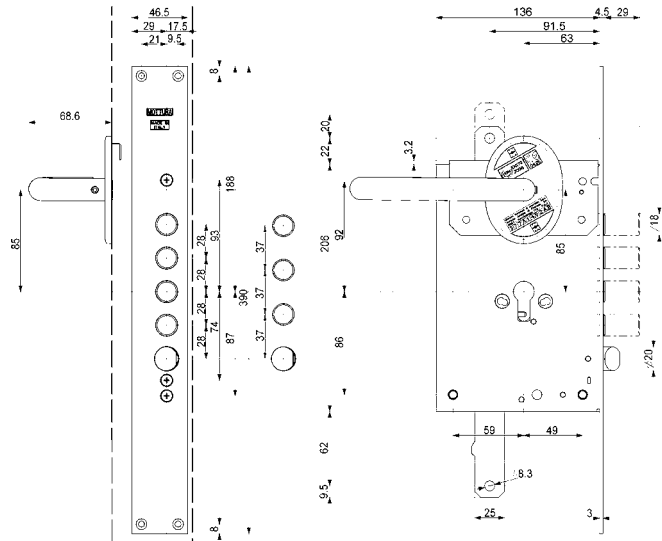

## 86.G271

MADE IN ITALY

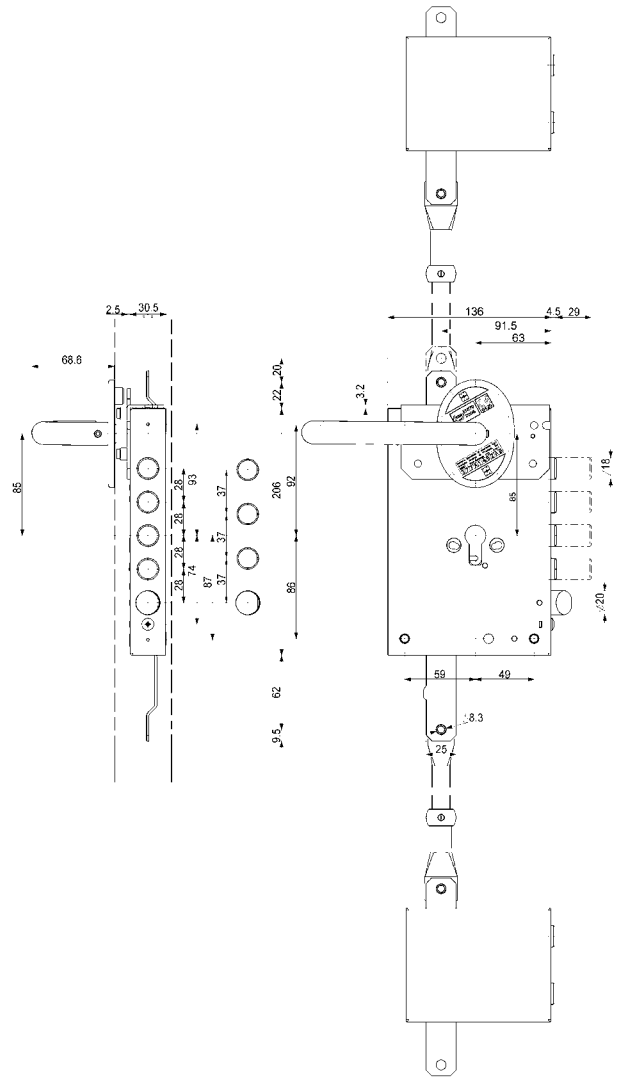

### Characteristics

**Variation in centre distance: ..../28 - ..../37**

- Side with 3/4 locking points
- Cylinder and handle backset 63 mm
- Latchbolt  $\varnothing$  20 mm operated by cylinder and handle
- Round bolt  $\varnothing$  18 mm with 29 mm travel
- Bar travel 20 mm
- All items are supplied left-handed and right-handed (specify the opening hand in the order and if the door is "PUSH" or "PULL")

Possibility to fit a double cylinder (key opens the door from both sides) or half cylinders (opening of the door from the outer side only + inside handle).  
Possibility to fit an external handle that operates latch bolt only.

Suitable only for single wing ARMoured doors with maximum width of 1320 mm.

**CERTIFIED ACCORDING TO UNI EN 179 WITH MARK**

### Characteristics

**Variation in centre distance: ..../28 - ..../37**

- Three-points 7/8 locking points
- Cylinder and handle backset 63 mm
- Latchbolt  $\varnothing$  20 mm operated by cylinder and handle
- Round bolt  $\varnothing$  18 mm with 29 mm travel
- Bar travel 20 mm
- Switchlocks art. 96251/28/37 (specificare nell'ordine)
- Bars
- All items are supplied left-handed and right-handed (specify the opening hand in the order and if the door is "PUSH" or "PULL")

Possibility to fit a double cylinder (key opens the door from both sides) or half cylinders (opening of the door from the outer side only + inside handle).  
Possibility to fit an external handle that operates latch bolt only.



Suitable only for single wing ARMoured doors with maximum width of 1320 mm.

**CERTIFIED ACCORDING TO UNI EN 179 WITH MARK**





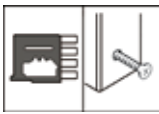

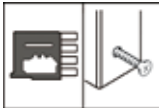
## SUPPLIED

Security locks with  
block lever on deadbolts

RIM LOCK				MORTISE-TYPE
	<b>86.G270D/S</b>		<b>86.G870D/S</b>	
	..B Block lever on bolts			
<p><b>Side with HANDLE 3/4 locking points</b>            Latchbolt Ø 20 mm operated by cylinder and <math>\square</math>8 handle square.            Complete with internal handle group (brass finish) and fixing plate.            Cylinder fixing with head screw.            Cylinders, reinforcements and other accessories are <b>NOT</b> included.</p>				
				
	<b>86.G271D/S</b>		<b>86.G871D/S</b>	
	..B Block lever on bolts			
<p><b>Three-points with HANDLE 7/8 locking points</b>            Latchbolt Ø 20 mm operated by cylinder and <math>\square</math>8 handle square.            Complete with internal handle group (brass finish) , fixing plate and            switchlocks art. 96.251/2 with bars.            Cylinder fixing with head screw.            Cylinders, reinforcements and other accessories are <b>NOT</b> included.</p>				
				

Use SWITCHLOCKS (Order separately: see section 96)						
96.086	96.086/50/53	96.087/56	96.087/112	96.251	96.251/28/37	96.371
						

Note: the use of different switchlocks from those reported, does NOT guarantee the proper functioning of the lock.

Use DEFENDER® (Order separately: see section 94)					WE RECOMMEND USING CHAMPIONS® SECURITY CYLINDERS 
TOP SYSTEM	LEVEL	BASIC	DF...		
					

### DOOR OPENING SIDE

To facilitate ordering, 4 door opening possibilities are illustrated. In cases 3 and 4, you have to specify "reversed latchbolt" in your order.



86.G270..SX



86.G270..DX

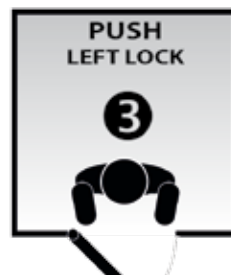

86.G270..SXR



86.G270..DXR

## 86.G371

MADE IN ITALY

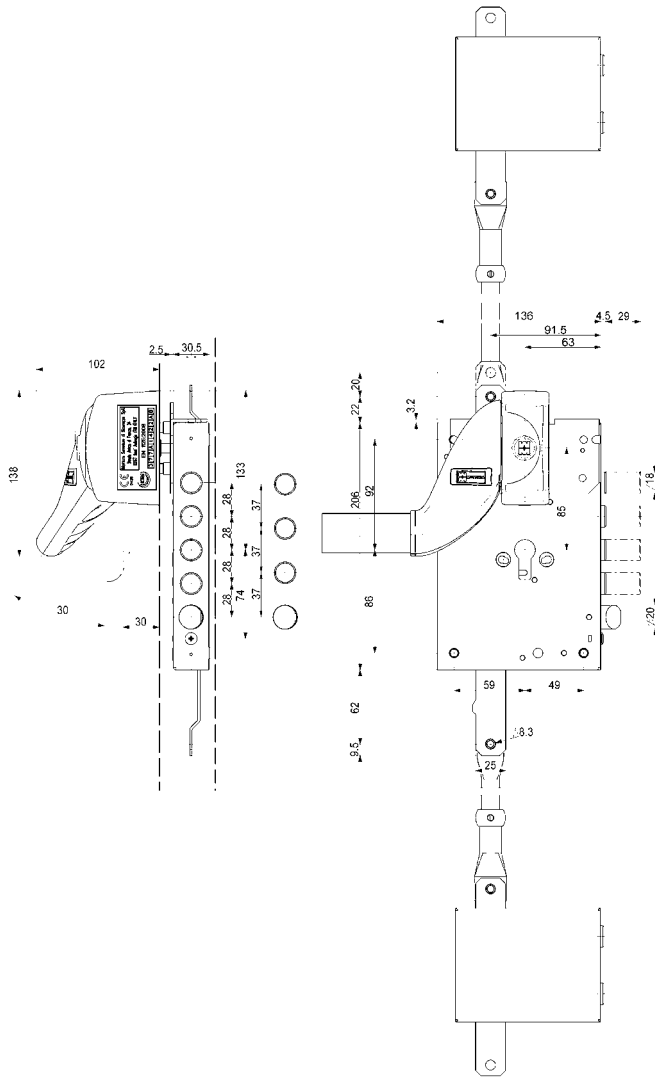

## 86.970A

MADE IN ITALY

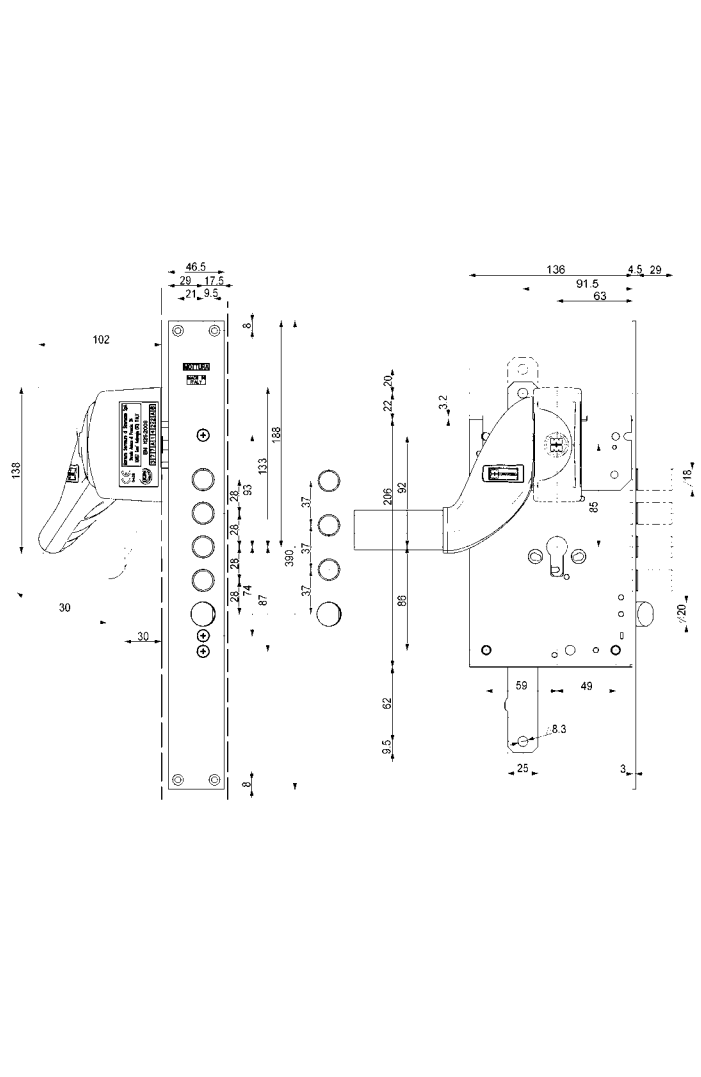

### Characteristics

#### Variation in centre distance: ..../28 - ..../37

- Side with 3/4 locking points
- Cylinder and handle backset 63 mm
- Latchbolt Ø 20 mm cylinder and handle operated
- Round bolt Ø 18 mm with 29 mm travel
- Bar travel 20 mm
- All items are supplied left-handed and right-handed (specify in the order). The door is always PUSH opening.

Possibility of fitting double cylinders (door opening with a key from both sides) or half-cylinder (door opening from the outside only + the inside panic exit bar). Possibility of fitting an external handle to operate the latch bolt only.

Suitable only for single wing ARMoured doors with maximum width of 1320 mm.

CERTIFIED ACCORDING TO UNI EN 1125 WITH MARK

### Characteristics

#### Variation in centre distance: ..../28 - ..../37

- Three-point 7/8 locking points
- Cylinder and handle backset 63 mm
- Latchbolt Ø 20 mm cylinder and handle operated
- Round bolt Ø 18 mm with 29 mm travel
- Bar travel 20 mm
- Switchlocks art. 96251/28/37 (specificare nell'ordine)
- Bars
- All items are supplied left-handed and right-handed (specify in the order). The door is always PUSH opening.

Possibility of fitting double cylinders (door opening with a key from both sides) or half-cylinder (door opening from the outside only + the inside panic exit bar). Possibility of fitting an external handle to operate the latch bolt only.





Suitable only for single wing ARMoured doors with maximum width of 1320 mm.

CERTIFIED ACCORDING TO UNI EN 1125 WITH MARK



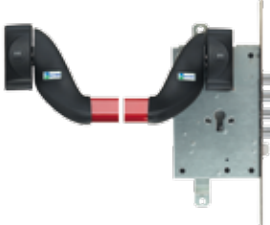
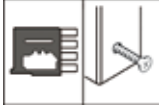



## SUPPLIED

Security locks with  
block lever on deadbolts

RIM LOCK			MORTISE-TYPE
	<h2>86.G370D/S    86.G970D/S</h2>		
	<p style="text-align: center;">..B Block lever on bolts</p> <p><b>Side with PANIC EXIT BAR 3/4 locking points</b>            Latchbolt Ø 20 mm operated by cylinder and 8 handle square.            Complete with fixing plate, internal handle group (black finish) and red bar with antimicrobial treatment.            Cylinder fixing with head screw.            Cylinders, reinforcements and other accessories are <b>NOT</b> included.</p> 		
	<h2>86.G371D/S    86.G971D/S</h2>		
	<p style="text-align: center;">..B Block lever on bolts</p> <p><b>Three-points with PANIC EXIT BAR 7/8 locking points</b>            Latchbolt Ø 20 mm operated by cylinder and 8 handle square.            Complete with fixing plate, internal handle group (black finish), red bar with antimicrobial treatment and switchlocks art. 96.251/2.            Cylinder fixing with head screw.            Cylinders, reinforcements and other accessories are <b>NOT</b> included.</p> 		

Use SWITCHLOCKS (Order separately: see section 96)						
96.086	96.086/50/53	96.087/56	96.087/112	96.251	96.251/28/37	96.371
						

Note: the use of different switchlocks from those reported, does NOT guarantee the proper functioning of the lock.

Use DEFENDER® (Order separately: see section 94)					WE RECOMMEND USING CHAMPIONS® SECURITY CYLINDERS 	
TOP SYSTEM	LEVEL	BASIC	DF...			
						

**DOOR OPENING SIDE**  
 To facilitate ordering, door opening possibilities are illustrated.



86.G370...SX



86.G370...DX

<b>86.GMAM0000</b>		
<b>Finish</b>		
brass finish		
Internal handle group and fixing plate.		

**FOR ACCESSORIES AND SPARE PARTS SERIES 86 REFER TO**



BARS **93**

**94**

FACE PLATES  
STRIKER PLATES



DEFENDER® **94**

**95**

ESCUTCHEONS



SWITCHLOCKS **96**

**99**

VARIOUS  
ACCESSORIES

