

40

DOUBLE-BITTED MORTISE LOCKS

MORTISE
LOCKS

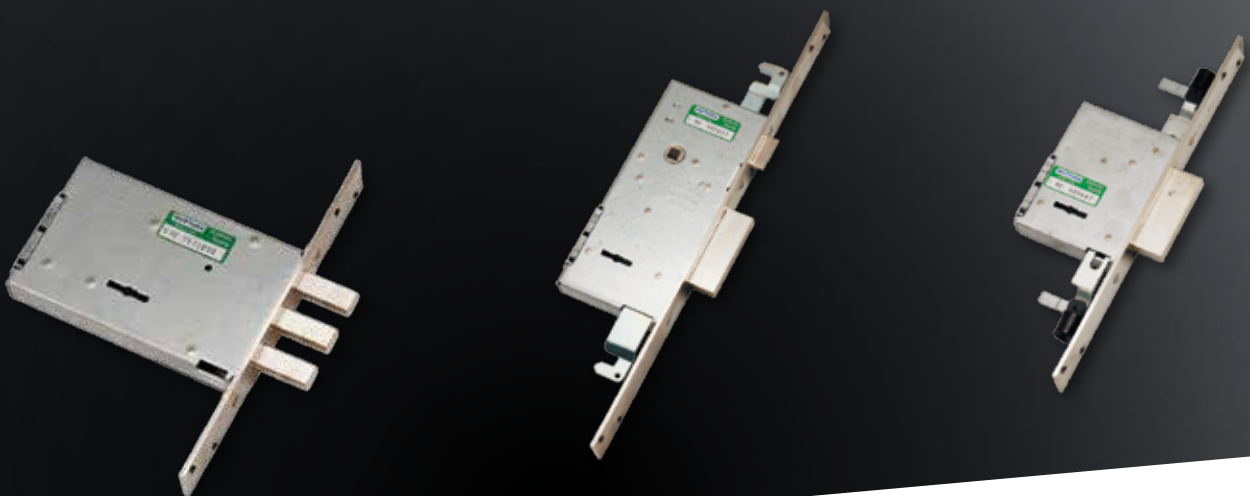

40.701

MADE IN ITALY

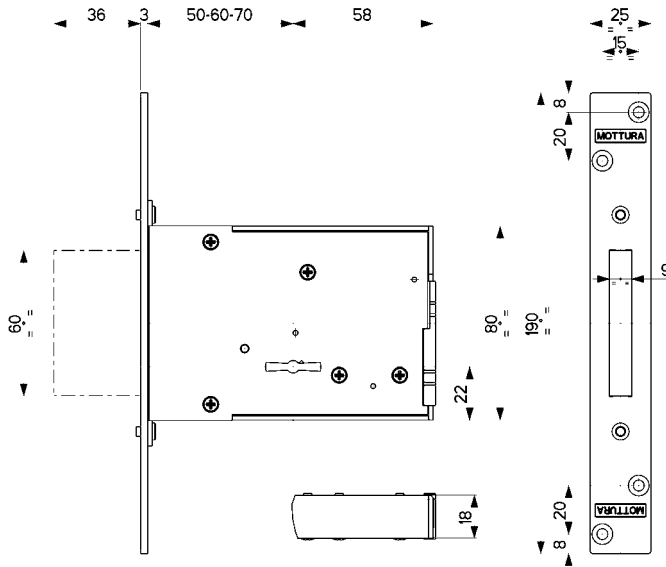

Characteristics

- Mortise-type locks for wooden and metal fixtures
- Side locks
- Backset 50/60/70 mm specify in the order
- All items are ambidextrous
- Finish: Zinc-plated box, nickel-plated or Zinc-plated face plate
- Single or multiple packs with locks with:
 - Keyed to differ
 - Keyed alike (KA)
- All packs include screws and small parts in addition to the specified accessories.

The price of articles supplied in packs is per unit unless otherwise specified in the price list.

Locks supplied with :
1/2/3 keys with 36 mm stem art.92292/5

On request the locks

- can be supplied with:
- 40 mm stem keys art. 92113/5
 - 60 mm stem keys art. 92256/5



40.701

Face plate Finish

Nickel-plated

Side lock - backset: 50/60/70
Bolt travel 36 mm

Supplied with:

- 3 keys with 36 mm stem art. 92292/5
- pair of brass escutcheons art. 95323/324
- striker plate art. 94282 (dim. 184x25x3 mm)

3 keys - 36 mm
art. 92292/5



40.702

Face plate Finish

Zinc-plated

Side lock - backset: 50/60/70
Bolt travel 36 mm

Supplied with:

- 2 keys 36 mm art. 92292/5 for each lock
- iron escutcheon art. 95281

Package of 6
with different coding

2 keys - 36 mm
art. 92292/5



40.704

Face plate Finish

Zinc-plated

Side lock - backset: 50/60/70
Bolt travel 36 mm

Supplied with:

- 1 key 36 mm art. 92292/5 for each lock
- iron escutcheon art. 95281

Package of 10 with KA

1 key - 36 mm
art. 92292/5



40.705

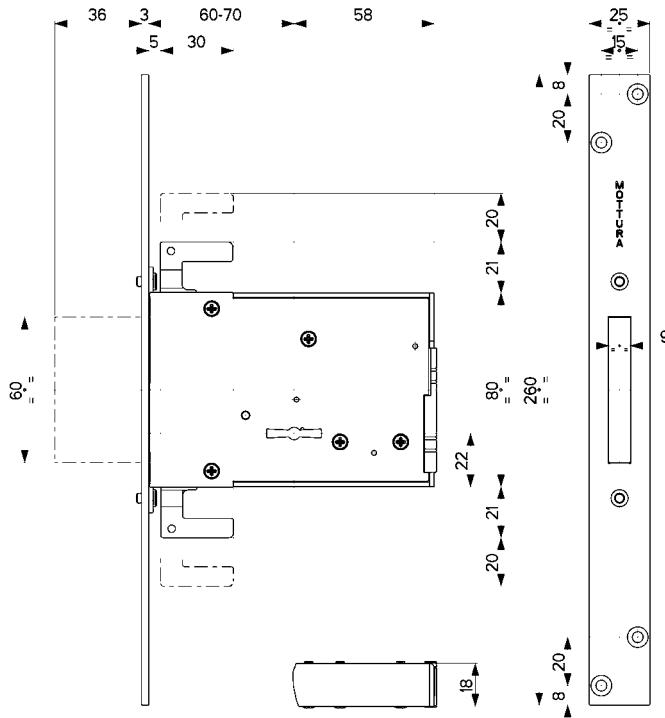

Characteristics

- Mortise-type locks for wooden and metal fixtures
- Three-points
- Backset 60/70 mm specify in the order
- All items are ambidextrous
- Finish: Zinc-plated box, nickel-plated or Zinc-plated face plate
- Single or multiple packs with locks with:
 - Keyed to differ
 - Keyed alike (KA)
- All packs include screws and small parts in addition to the specified accessories.
- Threaded bar fittings:
 - **M6** in plastic
 - **M8** in metal

The price of articles supplied in packs is per unit unless otherwise specified in the price list.

BARS NOT INCLUDED

See chapter 93 for combinations.

Locks supplied with
1/2/3 keys with 36 mm stem art.92292/5

On request the locks

- can be supplied with:
- 40 mm stem keys art. 92113/5
 - 60 mm stem keys art. 92256/5



40.705/M6/M8

Face plate Finish

Nickel-plated

Three-points lock - backset: 60/70

Bolt travel 36 mm
Bar travel 20 mm

- Supplied with:
- 3 keys 36 mm art. 92292/5
 - pair of brass escutcheons art. 95323/324
 - striker plate art. 94282 (dim. 184x25x3 mm)
 - upper striker plate and bar collars art. 99182
 - floor striker plate art. 99181
 - 2 threaded bar fittings
 - **M6 art. 99237006** in plastic or **M8 art. 99237008** in metal specify in the order
- Bars **NOT** included

3 keys - 36 mm
art. 92292/5

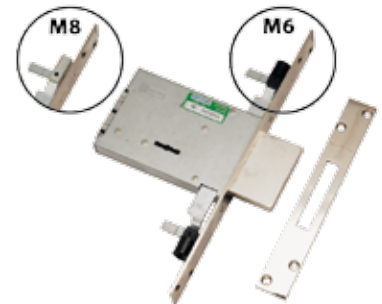

40.706/M6/M8

Face plate Finish

Zinc-plated

Three-points lock - backset: 60/70

Bolt travel 36 mm
Bar travel 20 mm

- Supplied with:
- 2 keys 36 mm art. 92292/5 per lock
 - iron escutcheon art. 95281
 - 2 threaded bar fittings
 - **M6 art. 99237006** in plastic or **M8 art. 99237008** in metal specify in the order
- Bars **NOT** included

Package of 6
with different coding

2 keys - 36 mm
art. 92292/5

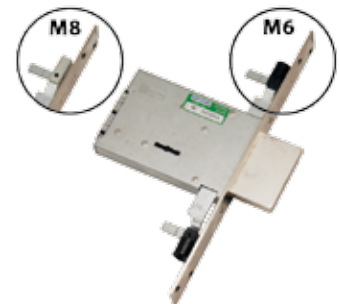

40.707/M6/M8

Face plate Finish

Zinc-plated

Three-points lock - backset: 60/70

Bolt travel 36 mm
Bar travel 20 mm

- Supplied with:
- 1 key 36 mm art. 92292/5 per lock
 - iron escutcheon art. 95281
 - 2 threaded bar fittings
 - **M6 art. 99237006** in plastic or **M8 art. 99237008** in metal specify in the order
- Bars **NOT** included

Package of 6/12 with KA

1 key - 36 mm
art. 92292/5

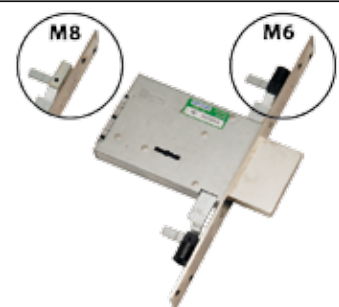

40.721

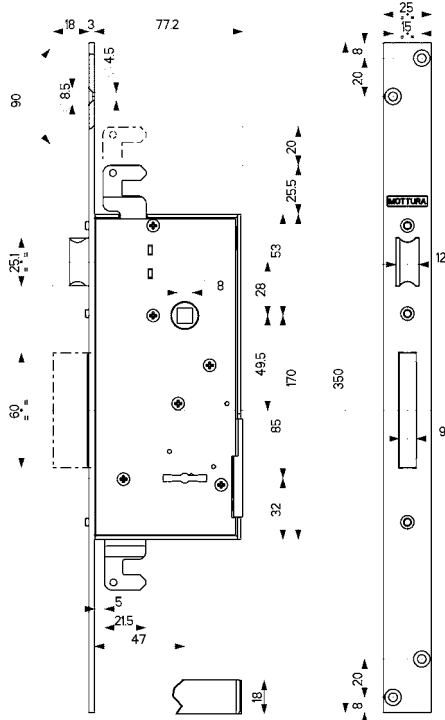

Characteristics

- Mortise-type locks for wooden and metal fixtures
- Side and Three-points locks
- Backset 47 mm
- All items are ambidextrous
- Finish:
Zinc-plated box, nickel-plated face plate
- All packs include screws and small parts in addition to the specified accessories

BARS NOT INCLUDED

See chapter 93 for combinations.

Locks supplied with
3 keys with 36 mm stem art.92292/5

On request the locks

can be supplied with:

- 40 mm stem keys art. 92113/5
- 60 mm stem keys art. 92256/5



40.711

Face plate Finish

Nickel-plated

Side lock - key and handle backset 47 mm

Reversible latchbolt
operated by handle square \square 8
Bolt travel 18 mm
Face plate dimensions 264x25x3 mm

Supplied with:

- 3 keys with 36 mm stem art. 92292/5
- pair of brass escutcheons art. 95323/324
- striker plate art. 94283 (dim. 264x25x3 mm)



40.721

Face plate Finish

Nickel-plated

Three-points lock - key and handle backset 47 mm

Reversible latchbolt
operated by handle square \square 8
Bolt travel 18 mm
Bar travel 20 mm
Face plate dimensions 350x25x3 mm

Supplied with:

- 3 keys 36 mm art. 92292/5
 - pair of brass escutcheons art. 95323/324
 - striker plate art. 94283 (dim. 264x25x3 mm)
 - upper striker plate and bar collars art. 99182
 - floor striker plate art. 99181
- Bars **NOT** included

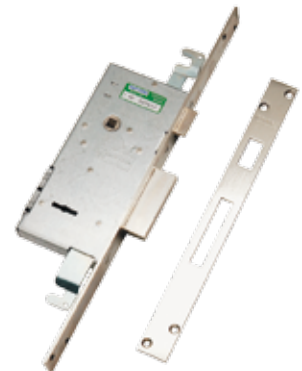

40.741

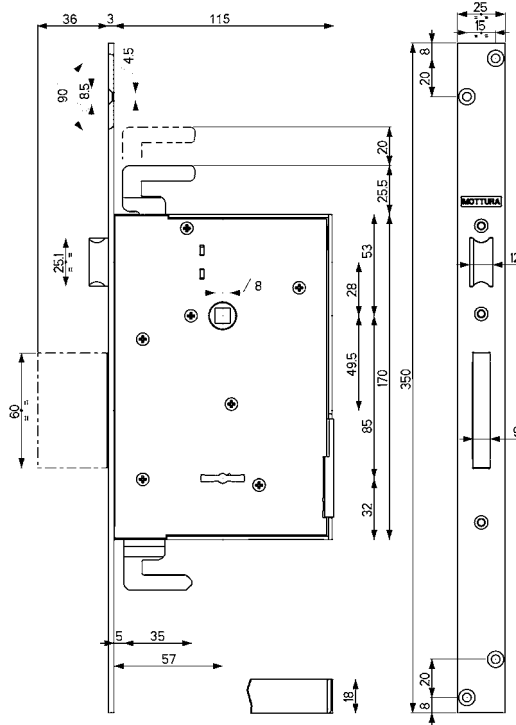

Characteristics

- Mortise-type locks for wooden and metal fixtures
- Side and Three-points locks
- Backset 57 mm
- All items are ambidextrous
- Finish:
Zinc-plated box, nickel-plated face plate
- All packs include screws and small parts in addition to the specified accessories

BARS NOT INCLUDED

See chapter 93 for combinations.

Locks supplied with
3 keys with 36 mm stem art.92292/5

On request the locks
can be supplied with:

- 40 mm stem keys art. 92113/5
- 60 mm stem keys art. 92256/5



40.731

Face plate Finish

Nickel-plated

Side lock - key and handle backset 57 mm

Reversible latchbolt
operated by handle square 8
Bolt travel 36 mm
Face plate dimensions 264x25x3 mm

Supplied with:

- 3 keys with 36 mm stem art. 92292/5
- pair of brass escutcheons art. 95323/324
- striker plate art. 94283 (dim. 264x25x3 mm)



40.741

Face plate Finish

Nickel-plated

Three-points lock - key and handle backset 57 mm

Reversible latchbolt
operated by handle square 8
Bolt travel 36 mm
Bar travel 20 mm
Face plate dimensions 350x25x3 mm

Supplied with:

- 3 keys 36 mm art. 92292/5
- pair of brass escutcheons art. 95323/324
- striker plate art. 94283 (dim. 264x25x3 mm)
- upper striker plate and bar collars art. 99182
- floor striker plate art. 99181
- Bars **NOT** included

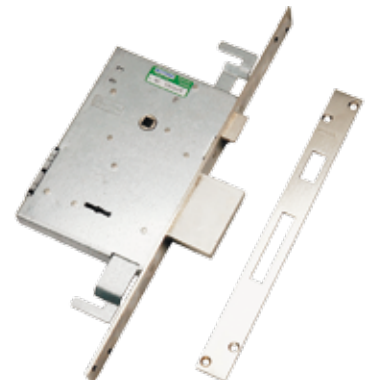
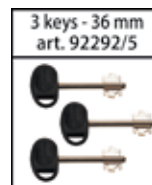

40.751

MADE
IN
ITALY

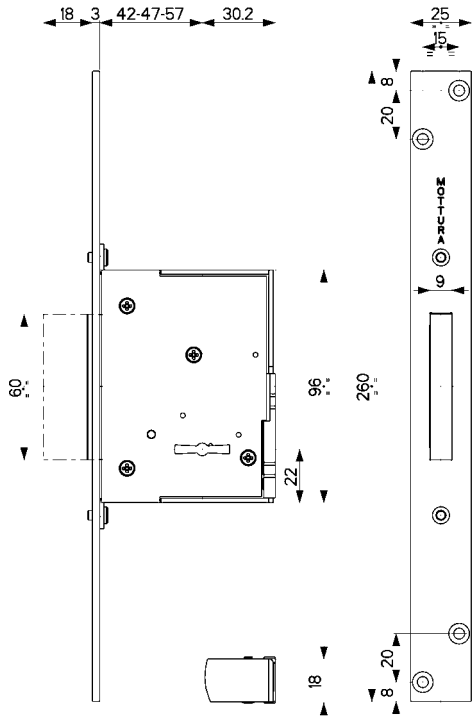

Characteristics

- Mortise-type locks for wooden and metal fixtures
- Side locks
- Backset 42/47/57 mm specify in the order
- All items are ambidextrous
- Finish:
Zinc-plated box, nickel-plated face plate
- All packs include screws and small parts in addition to the specified accessories

Locks supplied with :
3 keys with 36 mm stem art.92292/5

On request the locks
can be supplied with:
• 40 mm stem keys art. 92113/5
• 60 mm stem keys art. 92256/5



40.751

Face plate Finish

Nickel-plated

Side lock - backset: 42/47/57

Bolt travel 18 mm

Supplied with:

- 3 keys with 36 mm stem art. 92292/5
- pair of brass escutcheons art. 95323/324
- striker plate art. 94282 (dim. 184x25x3 mm)

3 keys - 36 mm
art. 92292/5



40.756

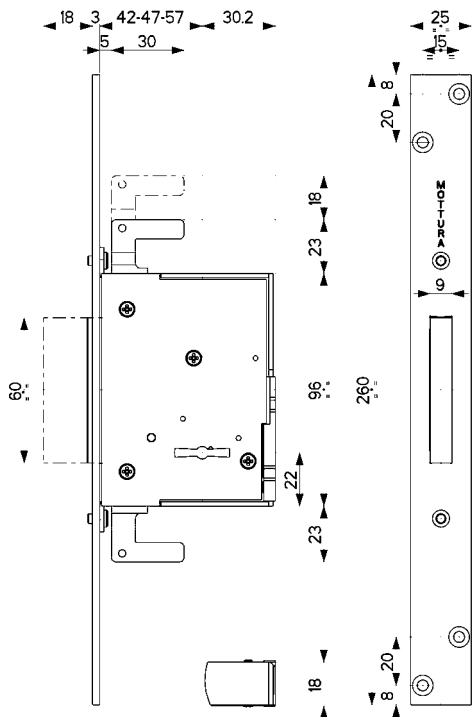

Characteristics

- Mortise-type locks for wooden and metal fixtures
- Three-points
- Backset 42/47/57 mm specify in the order
- All items are ambidextrous
- Finish:
Zinc-plated box, Zinc-plated face plate
- Multiple packs with locks with:
- Keyed to differ
- Keyed alike (KA)
- All packs include screws and small parts in addition to the specified accessories.
- Threaded bar fittings:
- M6 in plastic
- M8 in metal

The price of articles supplied in packs is per unit unless otherwise specified in the price list.

BARS NOT INCLUDED

See chapter 93 for combinations.

Locks supplied with :
1/2 keys with 36 mm stem art.92292/5

On request the locks

- can be supplied with:
- 40 mm stem keys art. 92113/5
 - 60 mm stem keys art. 92256/5



40.756/M6/M8

Face plate Finish

Zinc-plated

Three-points lock - backset: 42/47/57

Bolt travel 18 mm
Bar travel 20 mm

- Supplied with:
- 2 keys 36 mm art. 92292/5 per lock
 - iron escutcheon art. 95281
 - 2 threaded bar fittings
M6 art. 99237006 in plastic or
M8 art. 99237008 in metal
specify in the order.
- Bars **NOT** included
Package of 12 with different coding

2 keys - 36 mm
art. 92292/5

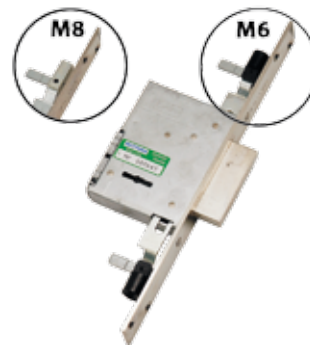

40.757/M6/M8

Face plate Finish

Zinc-plated

Three-points lock - backset: 42/47/57

Bolt travel 18 mm
Bar travel 20 mm

- Supplied with:
- 1 key 36 mm art. 92292/5 per lock
 - iron escutcheon art. 95281
 - 2 threaded bar fittings
M6 art. 99237006 in plastic or
M8 art. 99237008 in metal
specify in the order.
- Bars **NOT** included
Package of 12 with KA

1 key - 36 mm
art. 92292/5

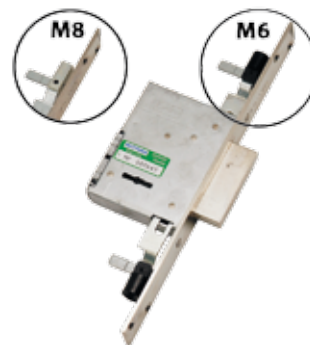

40.805

MADE IN ITALY

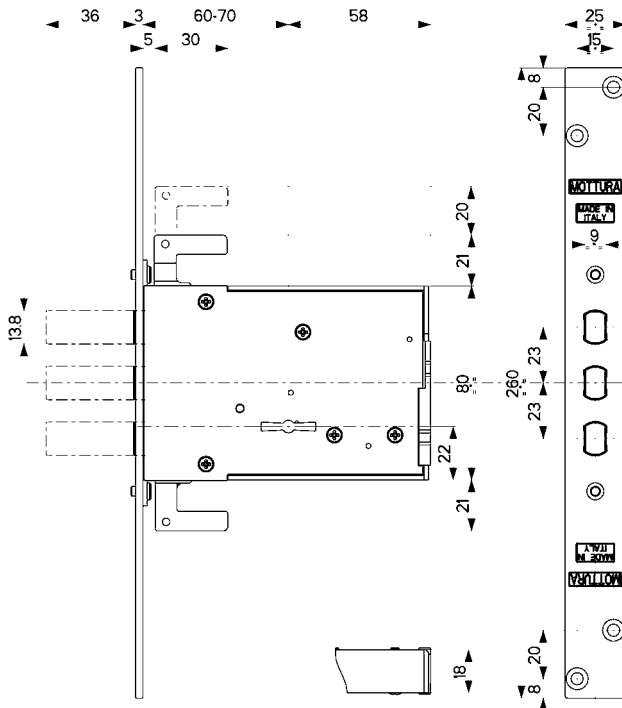

Characteristics

- Mortise-type locks for wooden and metal fixtures
- Side, Three-points
- Backset 60/70 mm specify in the order
- All items are ambidextrous
- Finish:
Zinc-plated box, nickel-plated or Zinc-plated face plate
- Single or multiple packs with locks with:
- different coding
- All packs include screws and small parts in addition to the specified accessories.
- Threaded bar fittings:
- M6 in plastic
- M8 in metal

The price of articles supplied in packs is per unit unless otherwise specified in the price list.

BARS NOT INCLUDED

See chapter 93 for combinations.

Locks supplied with
2/3 keys with 36 mm stem art.92292/5

On request the locks

- can be supplied with:
- 40 mm stem keys art. 92113/5
 - 60 mm stem keys art. 92256/5

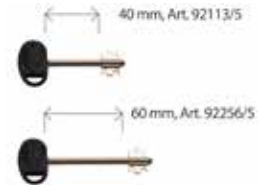

40.802

Face plate Finish

Zinc-plated

Side lock - backset: 60/70

Bolts travel mm 36

Supplied with:

- 2 keys 36 mm art. 92292/5 for each lock
- iron escutcheon art. 95281

Package of 6
with different coding

2 keys - 36 mm
art. 92292/5



40.805/M6/M8

Face plate Finish

Nickel-plated

Three-points lock - backset: 60/70

Bolts travel 36 mm

Bar travel 20 mm

Supplied with:

- 3 keys 36 mm art. 92292/5
- pair of brass escutcheons art. 95323/324
- striker plate art. 94337 (dim. 184x25x3 mm)
- upper striker plate and bar collars art. 99182
- floor striker plate art. 99181
- 2 threaded bar fittings

M6 art. 99237006 in plastic or
M8 art. 99237008 in metal
specify in the order.
Bars **NOT** included

3 keys - 36 mm
art. 92292/5

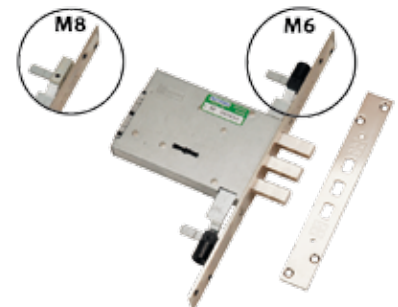

40.806/M6/M8

Face plate Finish

Zinc-plated

Three-points lock - backset: 60/70

Bolts travel 36 mm

Bar travel 20 mm

Supplied with:

- 2 keys 36 mm art. 92292/5 per lock
 - iron escutcheon art. 95281
 - 2 threaded bar fittings
- M6 art. 99237006 in plastic or
M8 art. 99237008 in metal
specify in the order.

Bars **NOT** included
Package of 6
with different coding

2 keys - 36 mm
art. 92292/5

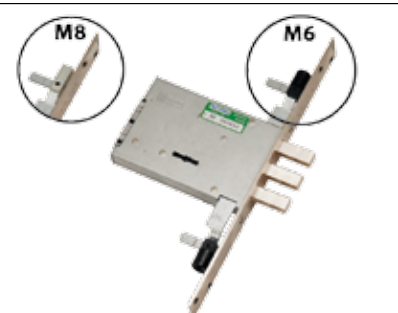

40.856

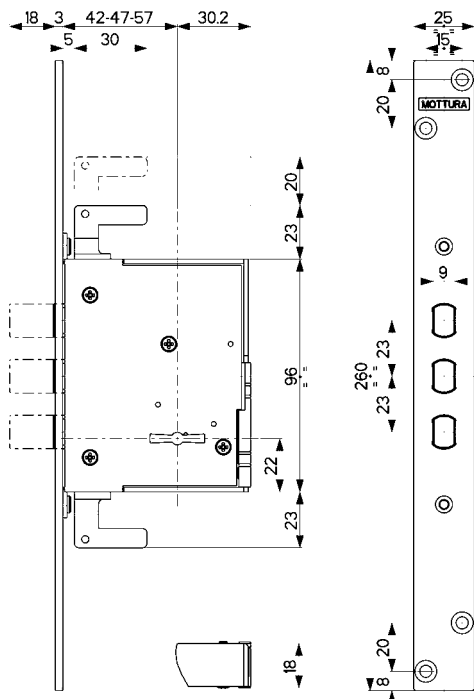

Characteristics

- Mortise-type locks for wooden and metal fixtures
- Side, Three-points
- Backset 42/47/57 mm specify in the order
- All items are ambidextrous
- Finish:
Zinc-plated box, Zinc-plated face plate
- Multiple packs with locks with:
- Keyed to differ
- All packs include screws and small parts in addition to the specified accessories.
- Threaded bar fittings:
- M6 in plastic
- M8 in metal

The price of articles supplied in packs is per unit unless otherwise specified in the price list.

BARS NOT INCLUDED

See chapter 93 for combinations.

Locks supplied with :
2 keys with 36 mm stem art.92292/5

- On request** the locks can be supplied with:
- 40 mm stem keys art. 92113/5
 - 60 mm stem keys art. 92256/5



40.852

Face plate Finish

Zinc-plated

Side lock - backset: 42/47/57

Bolts travel mm 18

- Supplied with:
- 2 keys 36 mm art. 92292/5 for each lock
 - iron escutcheon art. 95281

Package of 12 with different coding

2 keys - 36 mm art. 92292/5



40.856/M6/M8

Face plate Finish

Zinc-plated

Three-points lock - backset: 42/47/57

Bolts travel 18 mm

Bar travel 20 mm

- Supplied with:
- 2 keys 36 mm art. 92292/5 per lock
 - iron escutcheon art. 95281
 - 2 threaded bar fittings
 - **M6 art. 99237006** in plastic or **M8 art. 99237008** in metal specify in the order
 - Bars **NOT** included

package of 12 with different coding

2 keys - 36 mm art. 92292/5

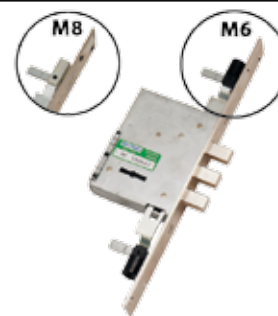

45

LOCKS FOR OVERHEAD DOORS AND SHUTTERS

RIM
LOCKS



45.853

MADE IN ITALY

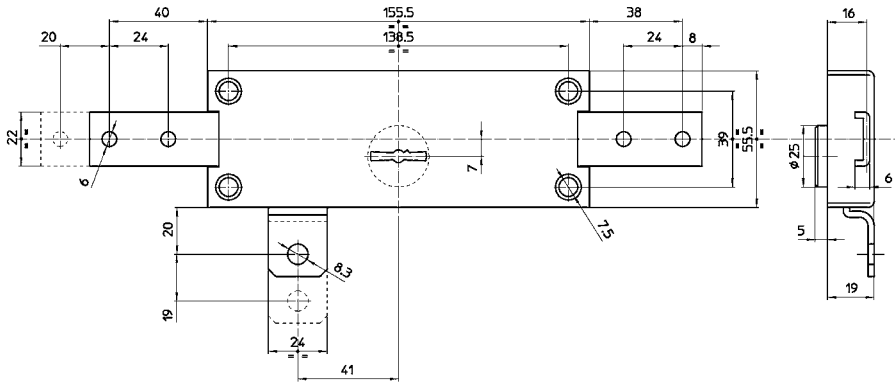

Characteristics

- Side, central or three-point locks with left-hand and/or right-hand locking
- Bar travel 20 mm
- Internal opening with key
- Single finish: Zinc-plated

Supplied with :

- 2 keys 36 mm stem art. 92292/5
- 1/2 fixing pins

BARS NOT INCLUDED

on request the locks can be supplied with:

- keys with 60 mm stem, art. 92256/5

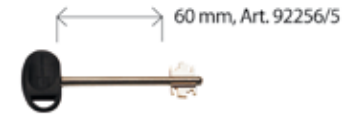

45.850

Bars **NOT** included

Finish

Zinc-plated

Central

Bar travel 20 mm
2 bar fixing pins (Ø9X14 mm)
right and left

2 keys - 36 mm
art. 92292/5



45.851

Bars **NOT** included

Finish

Zinc-plated

Central

with folded bar connectors
Bar travel 20 mm
2 bar fixing pins (Ø9X14 mm)
right and left

2 keys - 36 mm
art. 92292/5



45.853

Bars **NOT** included
Bar art. 93.089 on request

Finish

Zinc-plated

Three-point

Bar travel 20 mm
2 bar fixing pins (Ø9X14 mm)
right and left

2 keys - 36 mm
art. 92292/5



45.854

Bars **NOT** included
Bar art. 93.089 on request

Finish



Zinc-plated

Three-point

with folded bar connectors
Bar travel 20 mm
2 bar fixing pins (Ø9X14 mm)
right and left

2 keys - 36 mm
art. 92292/5



<h2>45.856/D</h2>	Bars NOT included	
Finish Zinc-plated	2 keys - 36 mm art. 92292/5	
Right side lock Bar travel 20 mm 1 bar fixing pins (Ø9X14 mm)		
<h2>45.856/S</h2>	Bars NOT included	
Finish Zinc-plated	2 keys - 36 mm art. 92292/5	
Right side lock with folded bar connector Bar travel 20 mm 1 bar fixing pins (Ø9X14 mm)		
<h2>45.857/D</h2>	Bars NOT included	
Finish Zinc-plated	2 keys - 36 mm art. 92292/5	
Right side lock with folded bar connector Bar travel 20 mm 1 bar fixing pins (Ø9X14 mm)		
<h2>45.857/S</h2>	Bars NOT included	
Finish Zinc-plated	2 keys - 36 mm art. 92292/5	
Left side lock with folded bar connector Bar travel 20 mm 1 bar fixing pins (Ø9X14 mm)		
<h2>45.859</h2>	Bars NOT included	
Finish Zinc-plated	2 keys - 36 mm art. 92292/5	
Right+left pair Bar travel 20 mm 2 keys with identical coding (KA) in total 2 bar fixing pins (Ø9X14 mm) right and left	 	
<h2>45.860</h2>	Bars NOT included	
Finish Zinc-plated	2 keys - 36 mm art. 92292/5	
Right+left pair with folded bar connectors Bar travel 20 mm 2 keys with identical coding (KA) in total 2 bar fixing pins (Ø9X14 mm) right and left	 	

FOR ACCESSORIES AND SPARE PARTS SERIES 45 REFER TO

	KEYS 92	93 BARS	
	STRIKER PLATES 94	95 ESCUTCHEONS	
	VARIOUS ACCESSORIES 99		

47

**LOCKS FOR
SLIDING AND
SWING DOORS
AND WINDOWS**

**FORZA 7
SHARK**



MORTISE
LOCKS



safeguarding your security

FORZA 7



Flat deadbolt with automatic anti-lift block.

For every type of outside doors and windows, grates, swinging gates.



Swing hook deadbolt.

For every type of outside doors and windows, grates, gates, sliding and swinging doors.



Swing DOUBLE hook deadbolt.

For every type of outside doors and windows, grates, gates, sliding and swinging doors.



Swing hook deadbolt with guide pin.

For sliding doors and windows only.



Reversible latchbolt.

Adjustable roller bolt.



A high-security "pin" is inserted in the bolt for maximum resistance against cutting tools.

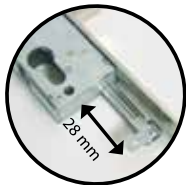

Increased bar travel (28 mm)
Ferrules are inserted completely into the frame for maximum strenght.

Characteristics

Mottura FORZA7 recalls the same technical know-how of armoured door locks, in compact size:

- Deadbolt, bars, latchbolt operated through \square 8 handle square
- Cylinder lock
- Fixing with cylinder screw
- Cylinder operable only when lock is locked
- Deadbolt with automatic anti-lift block
- Flat swing, hook deadbolts with cut-proof pin, with or without guidepin, or double hook deadbolts
- Bar travel 28 mm (mm 25-double hook)
- Bolt travel 24 mm (mm 25-double hook)
- Bars with mortise or threaded attachment
- Defender with through screws
- Slotted face and striker plates in stainless steel finish.

All items are REVERSIBLE.

In case of use of half cylinder, install type M.

Adatte per tubulari \square da 40 e 50 mm.

Tubulars	40	50
X	25	35
Y	40.5	50.5

For 40 tubulars, add 4 to art code (Es. 47105/M6/4)
For 50 tubulars, add 5 to art code (Es. 47105/M6/5)



Defender+escutcheons



Compact handle

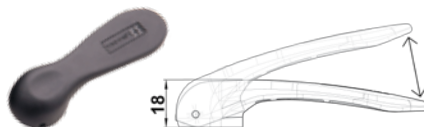

It is RECOMMENDED to use CHAMPIONS® security cylinders



SHARK

47.105

MADE
ITALY

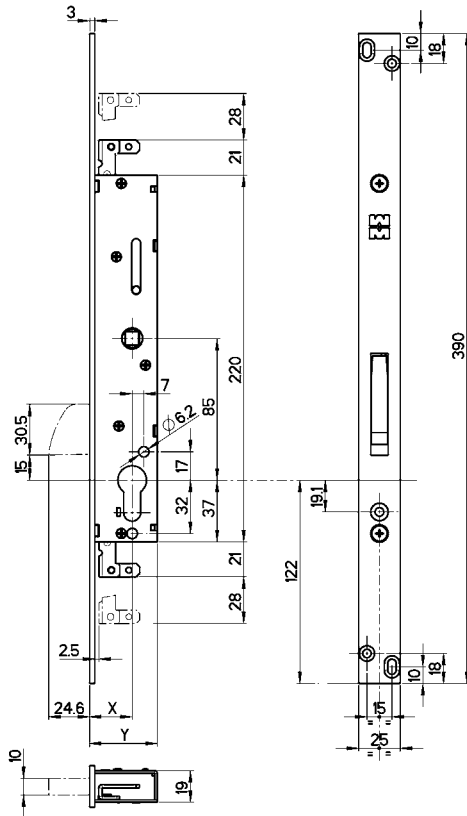

47.115

MADE
ITALY

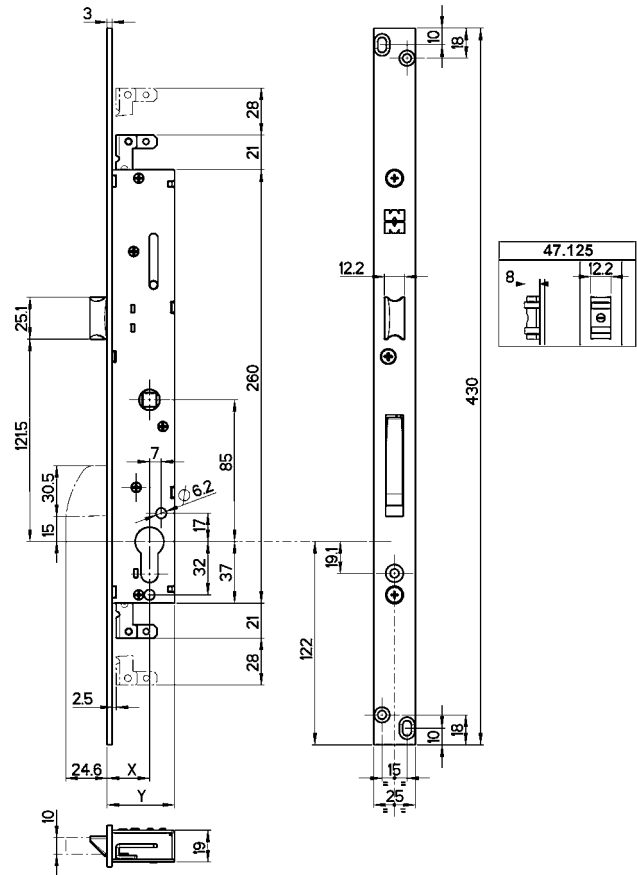

47.100

Face plate finish

Inox

Side lock

cylinder fastening by screw.
Key and handle backset 25/35 mm.
(specify /4 or /5 in the order)
Deadbolt operated through 8 handle square.

Deadbolt with automatic
anti-lifting lock and drill-resistant pin.
Cylinder actuated only when lock is locked
Bolt travel 24 mm
Accessories **NOT** included

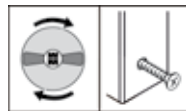

47.105

Face plate finish

Inox

Three-points lock

cylinder fastening by screw.
Key and handle backset 25/35 mm.
(specify /4 or /5 in the order)
Deadbolt and bars operated
through 8 handle square.

Deadbolt with automatic
anti-lifting lock and drill-resistant pin.
Cylinder actuated only when lock is locked
Bolt travel 24 mm
Bar travel 28 mm
Accessories **NOT** included

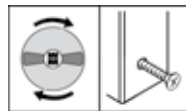

47.105/M6/M8

Face plate finish

Inox

Three-points lock

cylinder fastening by screw.
Key and handle backset 25/35 mm.
(specify /4 or /5 in the order)
Deadbolt and bars operated
through 8 handle square.

Deadbolt with automatic
anti-lifting lock and drill-resistant pin.
Cylinder actuated only when lock is locked
Bolt travel 24 mm - Bar travel 28 mm
2 threaded bar fittings **M6 art. 99237006** in plastic
or **M8 art. 99237008** metal
specify in the order,
Accessories **NOT** included

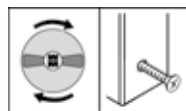

47.205

MADE
ITALY

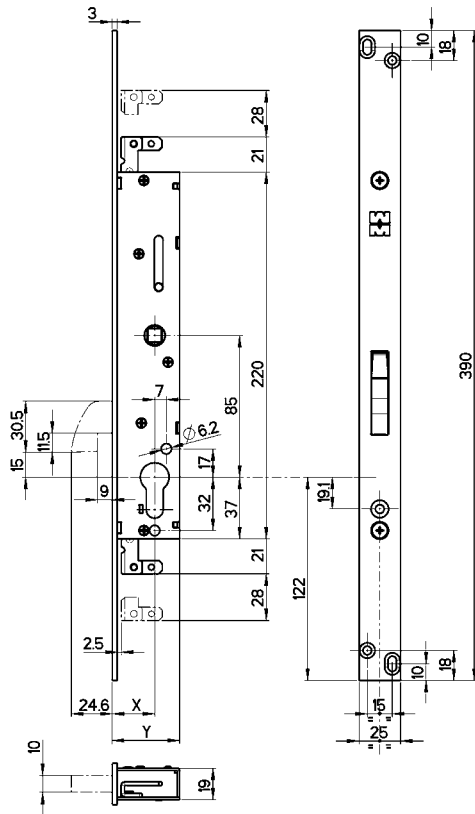

47.215

MADE
ITALY

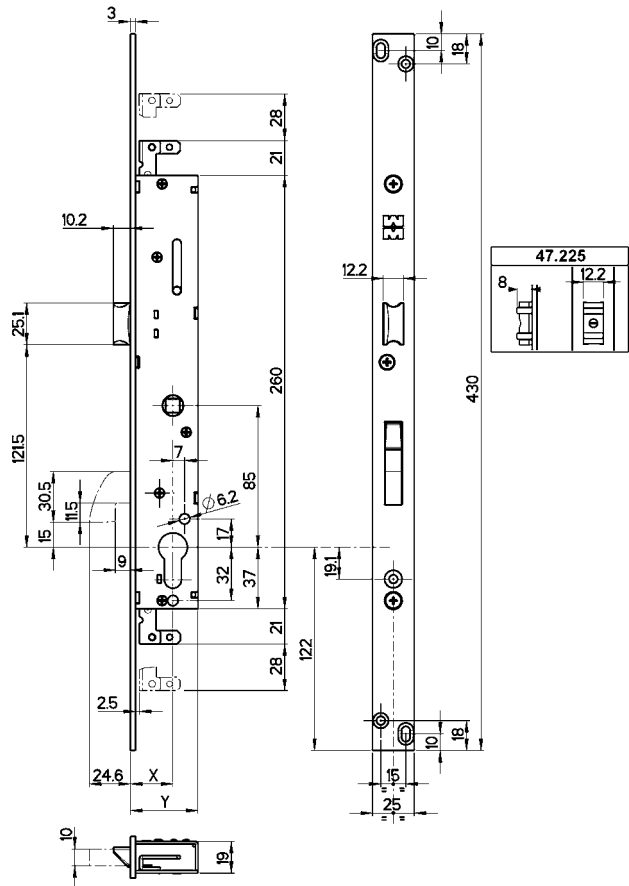

47.200

Face plate finish

Inox

Side lock

cylinder fastening by screw.
Key and handle backset 25/35.
(specify /4 or /5 in the order)
Deadbolt operated through 8 handle square.

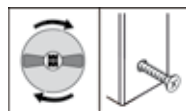

Deadbolt with automatic anti-lifting lock.
Cylinder actuated only when lock is locked
Bolt travel 24 mm
Accessories **NOT** included



47.205

Face plate finish

Inox

Three-points lock

cylinder fastening by screw.
Key and handle backset 25/35.
(specify /4 or /5 in the order)
Deadbolt and bars operated through 8 handle square.

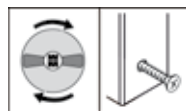

Deadbolt with automatic anti-lifting lock.
Cylinder actuated only when lock is locked
Bolt travel 24 mm
Bar travel 28 mm
Accessories **NOT** included



47.205/M6/M8

Face plate finish

Inox

Three-points lock

cylinder fastening by screw.
Key and handle backset 25/35.
(specify /4 or /5 in the order)
Deadbolt and bars operated through 8 handle square.

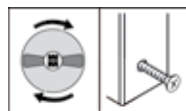

Deadbolt with automatic anti-lifting lock.
Cylinder actuated only when lock is locked
Bolt travel 24 mm - Bar travel 28 mm
2 threaded bar fittings **M6 art. 99237006** in plastic or **M8 art. 99237008** metal specify in the order,
Accessories **NOT** included



47.300

MADE
ITALY

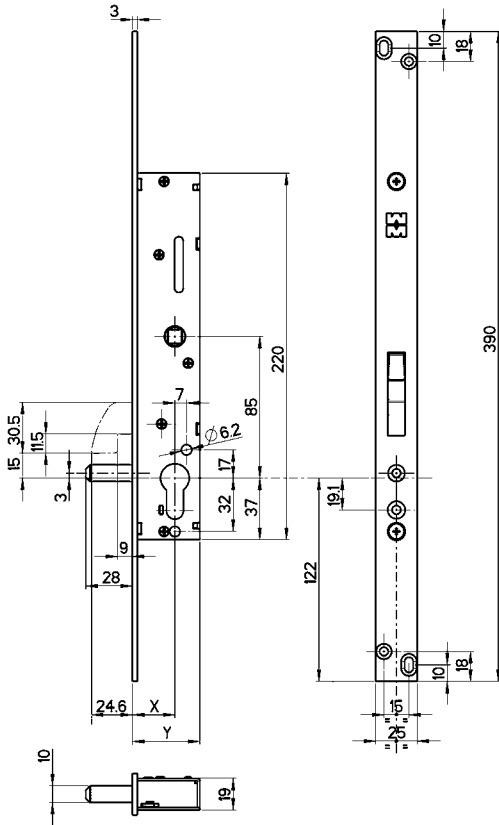

47.305

MADE
ITALY

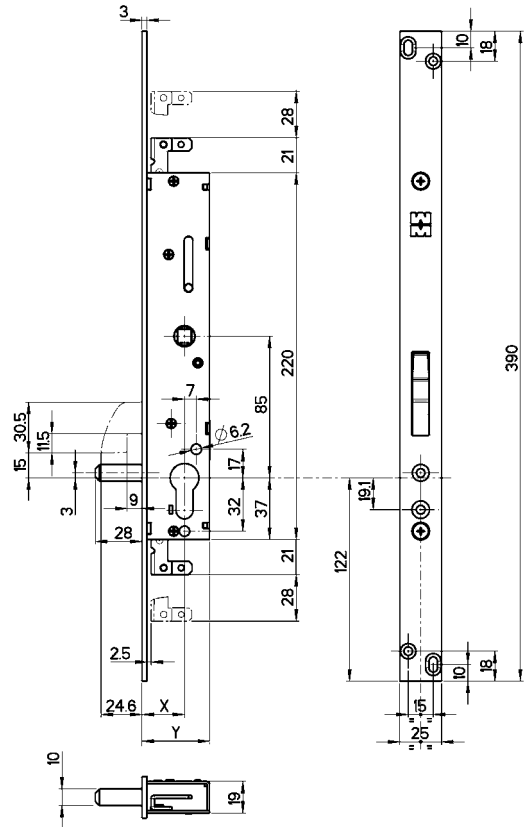

47.300

Face plate finish

Inox

Side lock with guide pin
cylinder fastening by screw.
Key and handle backset 25/35.
(specify /4 or /5 in the order)
Deadbolt operated through 8 handle square.

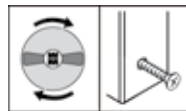

Deadbolt with automatic anti-lifting lock.
Cylinder actuated only when lock is locked
Bolt travel 24 mm
Accessories **NOT** included



47.305

Face plate finish

Inox

Three-points lock with guide pin
cylinder fastening by screw.
Key and handle backset 25/35.
(specify /4 or /5 in the order)
Deadbolt and bars operated
through 8 handle square.

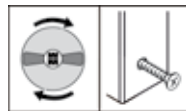

Deadbolt with automatic anti-lifting lock.
Cylinder actuated only when lock is locked
Bolt travel 24 mm
Bar travel 28 mm
Accessories **NOT** included



47.305/M6/M8

Face plate finish

Inox

Three-points lock with guide pin
cylinder fastening by screw.
Key and handle backset 25/35.
(specify /4 or /5 in the order)
Deadbolt and bars operated
through 8 handle square.

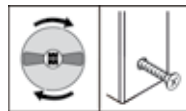

Deadbolt with automatic anti-lifting lock.
Cylinder actuated only when lock is locked
Bolt travel 24 mm - Bar travel 28 mm
2 threaded bar fittings **M6 art. 99237006** in plastic
or **M8 art. 99237008** metal
specify in the order.
Accessories **NOT** included



47.505

MADE IN ITALY

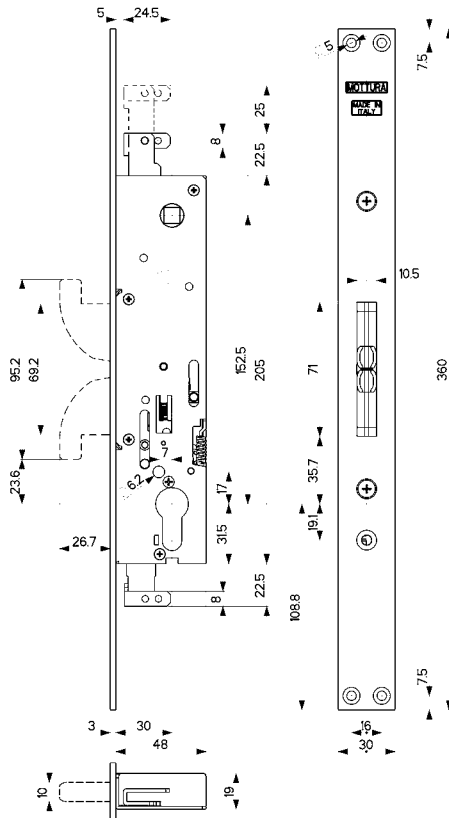

Characteristics

- Deadbolt, bars, latchbolt operated through \square 8 handle square.
- Cylinder actuated only when lock is locked
- Fixing with cylinder screw
- Double HOOK deadbolt
- Deadbolt with automatic anti-lifting lock.
- Bar travel 25 mm
- Bolt travel 26 mm
- Bars with mortise or threaded attachment
- Defender with through screws
- Slotted face and striker plates in Zinc-plated finish.

The article is REVERSIBLE

We recommend using Defender® MOTTURA for greater protection of the lock and the cylinder.

CYLINDER AND OTHER ACCESSORIES ARE NOT INCLUDED.

ON REQUEST
Lock with forced cylinder extraction protection system

It is RECOMMENDED to use CHAMPIONS® security cylinders



47.505

Face plate finish

Zinc-plated

Three-points lock

with double HOOK deadbolt cylinder fastening by screw.
Key and handle backset mm 30
Deadbolt and bars operated through \square 8 handle square.
Bolt travel 26 mm - Bar travel 25 mm

Deadbolt with automatic anti-lifting lock.
Cylinder actuated only when lock is locked

Accessories **NOT** included

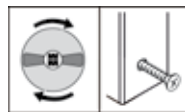

47.505/M6/M8

Face plate finish

Zinc-plated

Three-points lock

with double HOOK deadbolt cylinder fastening by screw.
Key and handle backset mm 30
Deadbolt and bars operated through \square 8 handle square.
Bolt travel 26 mm - Bar travel 25 mm

Deadbolt with automatic anti-lifting lock.
Cylinder actuated only when lock is locked

2 threaded bar fittings
M6 art. 99237006 in plastic or
M8 art. 99237008 metal
specify in the order.
Accessories **NOT** included

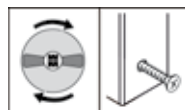

47.506

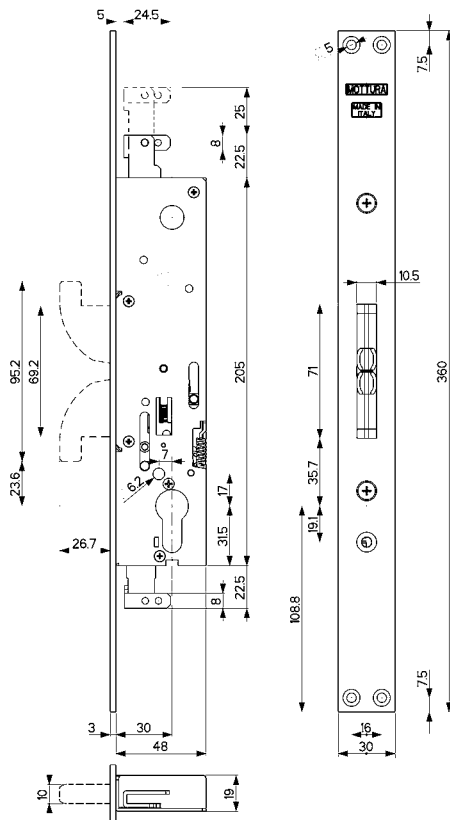

MADE IN ITALY

Characteristics

- Deadbolt, bars, latchbolt operated by cylinder
- Fixing with cylinder screw
- Double HOOK deadbolt
- Deadbolt with automatic anti-lifting lock.
- Bar travel 25 mm
- Bolt travel 26 mm
- Bars with mortise or threaded attachment
- Defender with through screws
- Slotted face and striker plates in Zinc-plated finish.

The article is REVERSIBLE

We recommend using Defender® MOTTURA for greater protection of the lock and the cylinder.

CYLINDER AND OTHER ACCESSORIES ARE NOT INCLUDED.

ON REQUEST
Lock with forced cylinder extraction protection system

It is RECOMMENDED to use CHAMPIONS® security cylinders



MORTISE LOCKS

<h2 style="margin: 0;">47.506</h2>	<p>Deadbolt with automatic anti-lifting lock.</p>	
<p>Face plate finish</p> <p>Zinc-plated</p>	<p>Accessories NOT included</p>	
<p>Three-points lock with double HOOK deadbolt cylinder fastening by screw. Key backset mm 30 Deadbolt and bars operated by cylinder. Bolt travel 26 mm - Bar travel 25 mm</p>		
<h2 style="margin: 0;">47.506/M6/M8</h2>	<p>Deadbolt with automatic anti-lifting lock. 2 threaded bar fittings M6 art. 99237006 in plastic or M8 art. 99237008 metal specify in the order. Accessories NOT included</p>	
<p>Face plate finish</p> <p>Zinc-plated</p>	<p>Accessories NOT included</p>	
<p>Three-points lock with double HOOK deadbolt cylinder fastening by screw. Key backset mm 30 Deadbolt and bars operated by cylinder. Bolt travel 26 mm - Bar travel 25 mm</p>		

96.105

MADE
ITALY

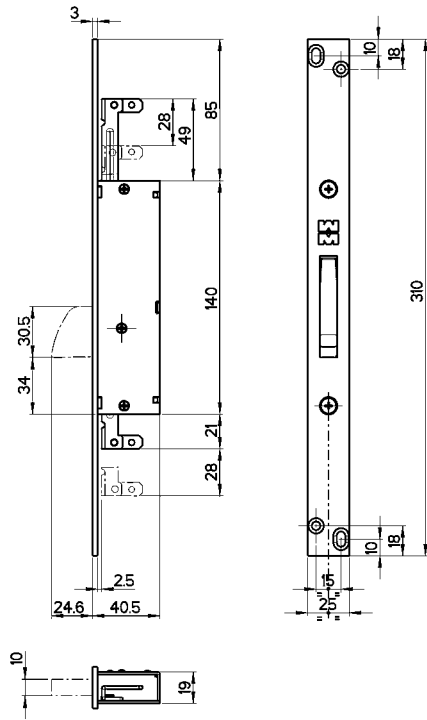

96.205

MADE
ITALY

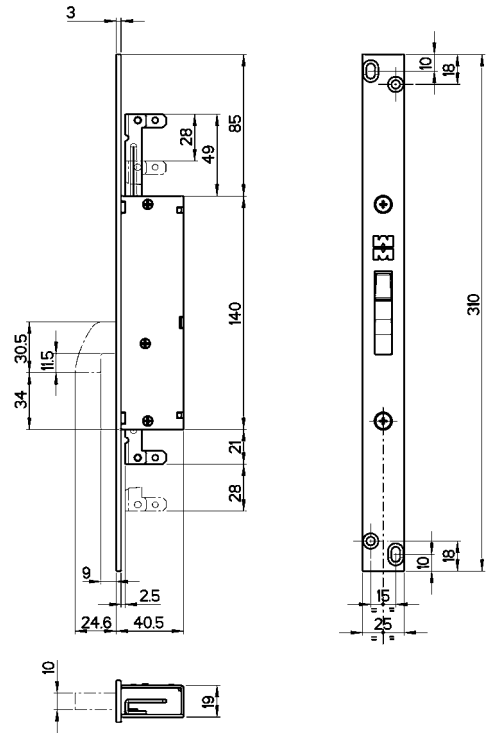

96.105...

Code	Face plate finish
96.105	Inox
96.105M6	Inox
96.105M8	Inox

Ambidextrous mortise-type switchlock
Flat deadbolt
Bolt travel 24 mm
Bar travel 28 mm

Mortise-type or threaded bar fittings
M6 art. 99237006 in plastic or
M8 art. 99237008 metal
specify in the order,
Accessories **NOT** included



96.205...

Code	Face plate finish
96.205	Inox
96.205M6	Inox
96.205M8	Inox

Ambidextrous mortise-type switchlock
Hook deadbolt
Bolt travel 24 mm
Bar travel 28 mm

Mortise-type or threaded bar fittings
M6 art. 99237006 in plastic or
M8 art. 99237008 metal
specify in the order,
Accessories **NOT** included



96.405

MADE
ITALY

96.415

MADE
ITALY

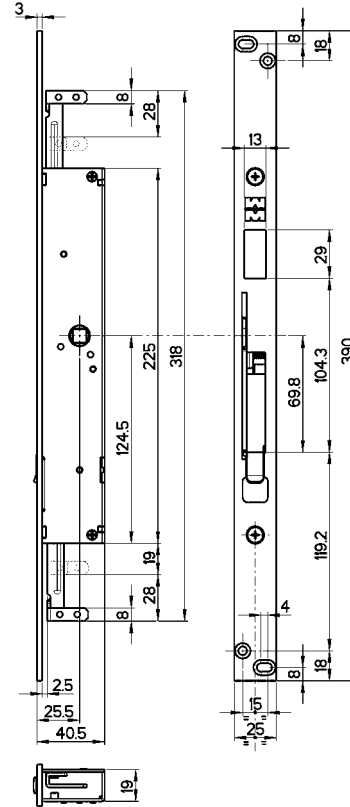
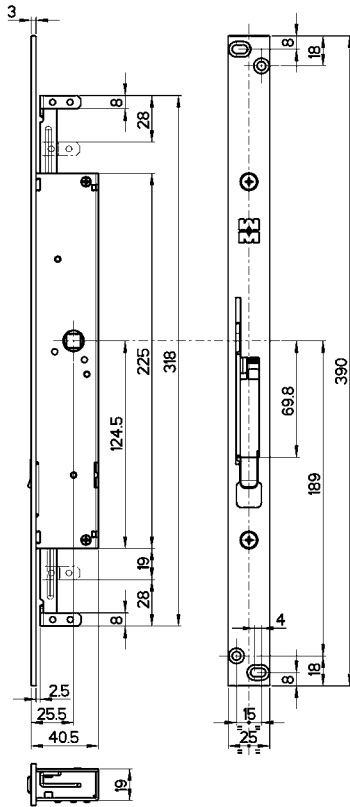

96.404...

Code	Face plate finish
96.404	Inox
96.404M6	Inox
96.404M8	Inox

Mortise-type locking and release striker plate for second wing (for locks WITHOUT latchbolt and WITHOUT hook)
Handle axes 25.5 mm
Activation by \square 8 handle.
Bar travel 28 mm



Mortise-type or threaded bar fittings
M6 art. 99237006 in plastic or
M8 art. 99237008 metal
specify in the order,
Accessories **NOT** included

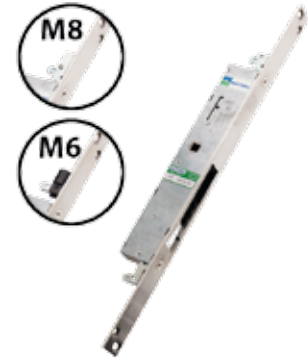

96.405...

Code	Face plate finish
96.405	Inox
96.405M6	Inox
96.405M8	Inox

Mortise-type locking and release striker plate for second wing (for locks WITHOUT latchbolt and WITHOUT hook)
Handle axes 25.5 mm
Activation by \square 8 handle or 90° travel lever.
Bar travel 28 mm



Mortise-type or threaded bar fittings
M6 art. 99237006 in plastic or
M8 art. 99237008 metal
specify in the order,
Accessories **NOT** included



96.505

MADE IN ITALY

Characteristics

- Powered by PIN screw
- Bars travel 25 mm
- Mortise-type or threaded bar fittings
- Face plates and striker plates in Zinc-plated finish

The article is **REVERSIBLE**

ACCESSORIES NOT INCLUDED.

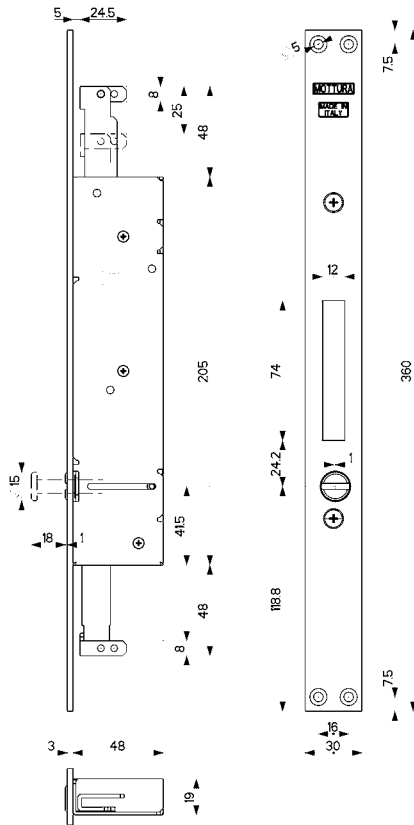

96.505...

Code	Face plate finish
96.505	Zinc-plated
96.505M6	Zinc-plated
96.505M8	Zinc-plated

Locking for second wing for armoured doors (For locks with DOUBLE HOOK 47505/506)
Powered by PIN screw placed on the faceplate.
Bars travel 25 mm

Mortise-type or threaded bar fittings
M6 art. 99237006 in plastic or
M8 art. 99237008 metal
specify in the order,
Accessories **NOT** included

